

WEBSTERVILLE ROAD

OLD YARD 4
SECTION A

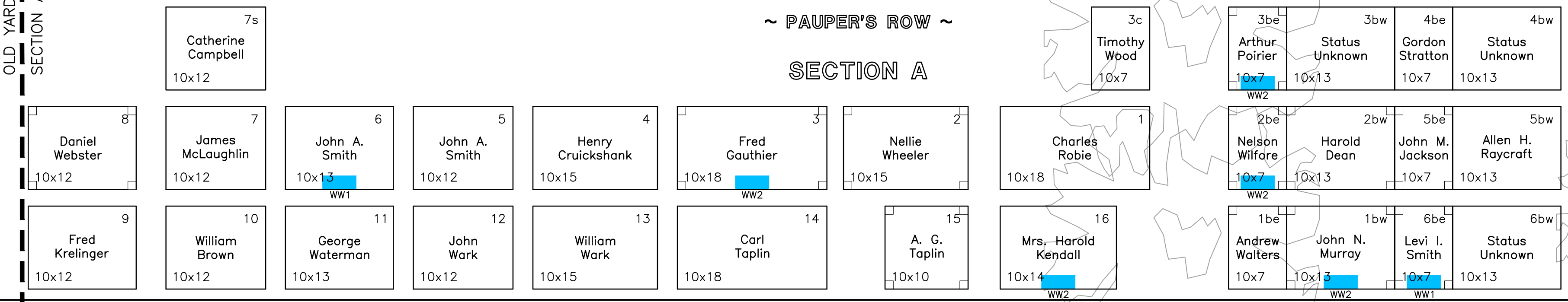

~ PAUPER'S ROW ~
SECTION A

PAVED DRIVEWAY

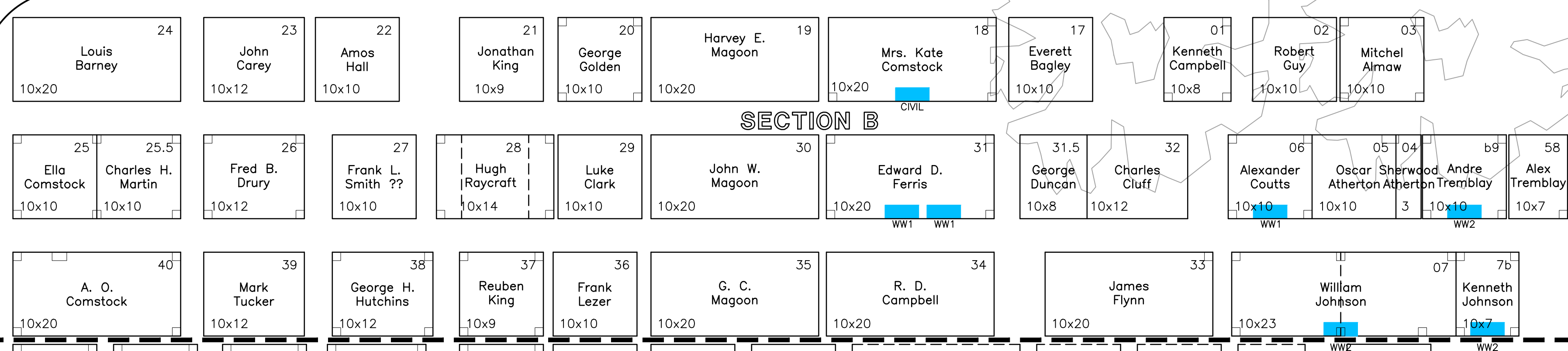

SECTION B

SECTION B
SECTION C

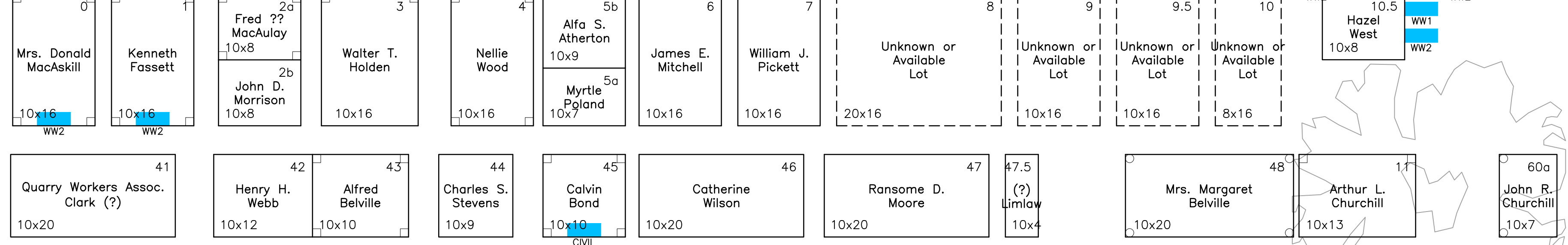

SECTION C

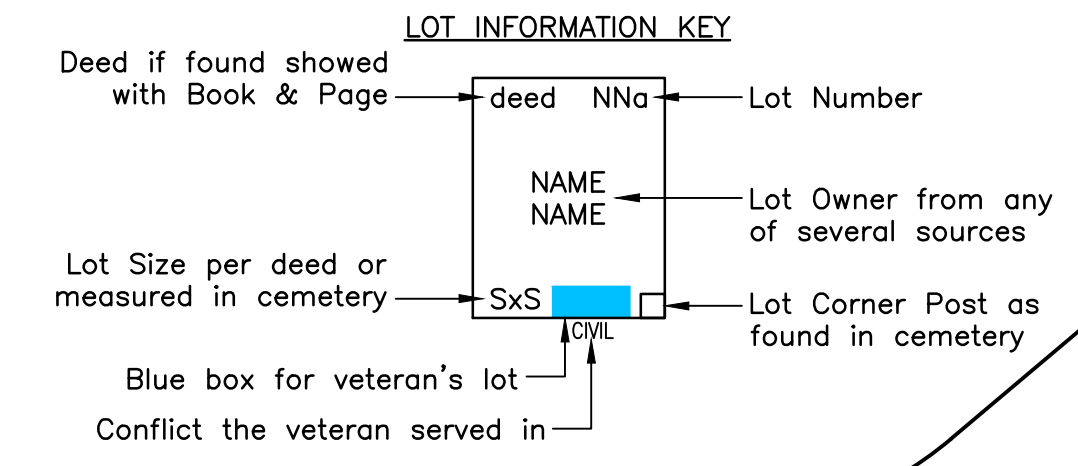
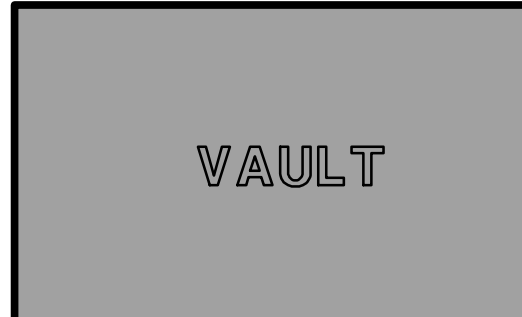

VAULT

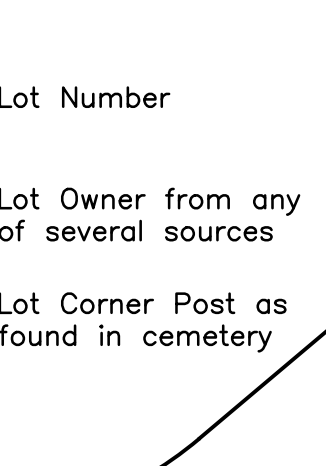

WILSON CEMETERY
BARRE TOWN, VERMONT
Sections A, B, and C Schematic
Cemetery Year 2015

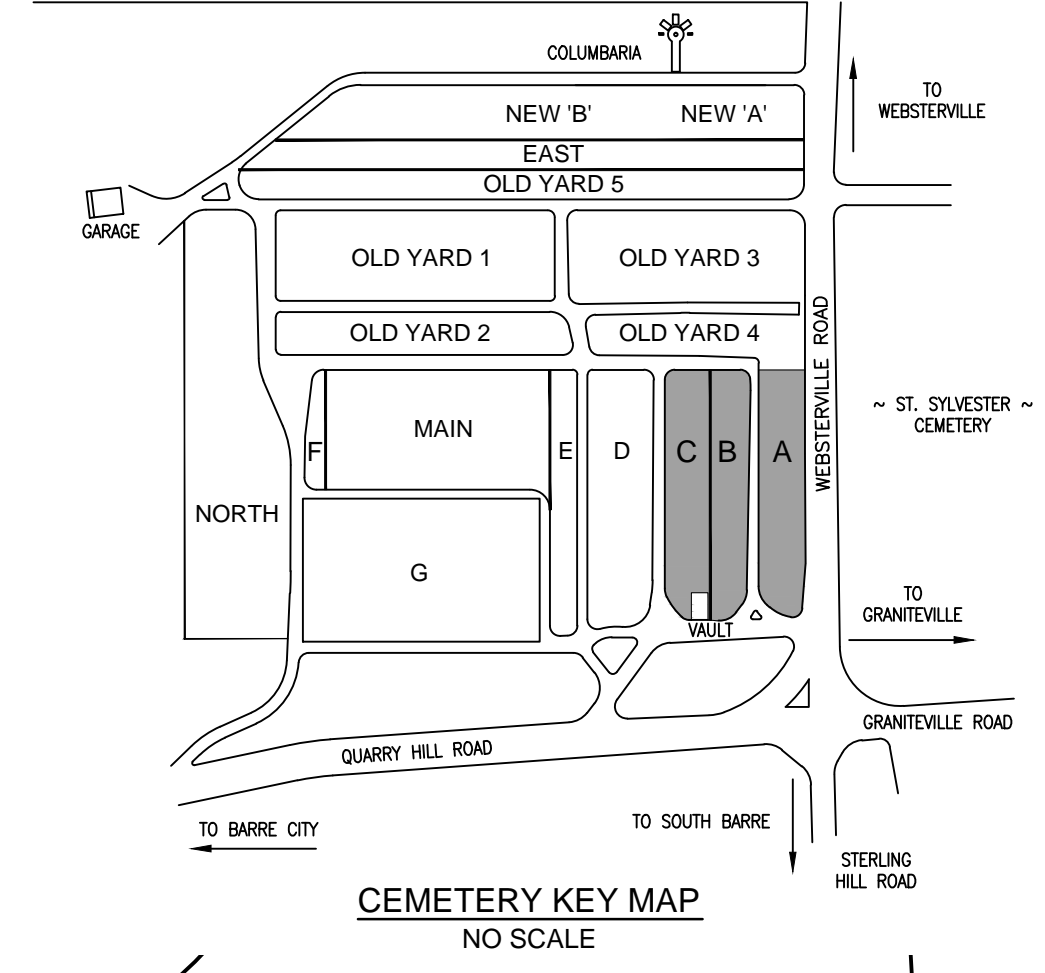

CEMETERY KEY MAP
NO SCALE

SECTION D

PAVED DRIVEWAY

PAVED DRIVEWAY

PAVED DRIVEWAY

OLD YARD 4